



## 04 | FASTENERS

There are a number of TSLOTS fasteners for you to choose from. Economy T-Nuts are the most economical way to fasten your assembly. Anchor fasteners are a lower cost alternative to make a strong, clean, flush 90 degree joint in a variable location. End fasteners allow your frame to have a strong, square, hidden joint in a fixed location that makes assembly of your frame easier.

### **WHEN ORDERING FASTENERS FOR YOUR APPLICATION, KEEP THESE SUGGESTIONS IN MIND:**

- Check out the Fastener Application Test to determine which fasteners are right for your job - Page 04:02
- For the most cost effective fastening option, choose economy t-nuts and fasteners
- When you have a captivated extrusion end, select drop-in t-nuts and fasteners
- Check out the Tools section of the catalog to find the right tool for your job

### **FASTENER ADVANTAGES**

- Options allow loading from end or from side
- Many available in fractional and metric sizes
- Highest quality available
- Finishes include corrosion resistant black zinc, bright zinc and stainless steel
- Clean flush connections easily achieved

» *See page 01:02 for Torque Specifications*

# Fasteners

## FASTENER/TOOL RECOMMENDED CHART

THREAD SIZE	FASTENER HEAD			
	SHCS	BHSCS	FBHSCS	FHSCS
8/32	n/a	3/32"	n/a	n/a
10-32	5/32"	1/8"	n/a	n/a
1/4-20	3/16"	5/32"	5/32"	5/32"
5/16-18	1/4"	3/16"	3/16"	3/16"
3/8-16	5/16"	n/a	n/a	7/32"
M6	5mm	4mm	n/a	n/a
M8	6mm	5mm	n/a	n/a

\* Numbers in chart reflect hex tool size required.

## FASTENER APPLICATION TEST

FASTENER	TS10-10		TS15-15L		TS15-15	
	A (lbs)	B	A (lbs)	B	A (lbs)	B
1	500	180 in/lbs	950	540 in/lbs	950	700 in/lbs
2	900	250 in/lbs	1,200	1,150 in/lbs	1,200	2,000 in/lbs
3	450	325 in/lbs	1,000	680 in/lbs	1,000	1,150 in/lbs
4	175	400 in/lbs	225	1,000 in/lbs	225	1,100 in/lbs
5	175	500 in/lbs	250	1,200 in/lbs	250	1,260 in/lbs
6	325	180 in/lbs	375	500 in/lbs	575	500 in/lbs
7	325	260 in/lbs	375	500 in/lbs	575	500 in/lbs

\* All forces are approximate.

**A - DIRECT FORCE**  
**B - TORTIONAL FORCE**

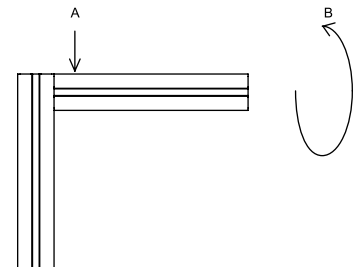

**1 - SINGLE ANCHOR**

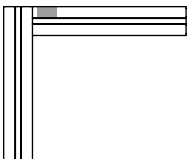

**2 - DOUBLE ANCHOR**

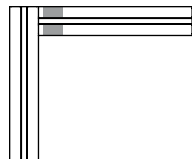

**3 - END FASTENER**

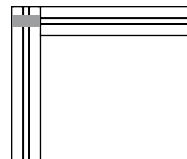

**4 - JOINING PLATE**

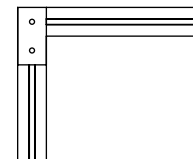

**5 - 90° JOINING PLATE**

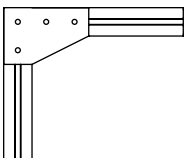

**6 - CORNER BRACKET**

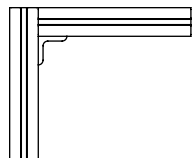

**7 - CORNER GUSSET**

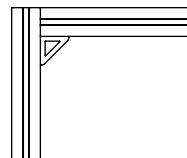

## ECONOMY T-NUTS



- Economical
- High Strength
- Extrusion end loading only
- 10, 15, 25 & 40 Series sizes

ITEM #	DESCRIPTION	THREAD
651095	Black Zinc 10 S Economy T-Nut	8-32 (10S)
651096	Black Zinc 10 S Economy T-Nut	10-32 (10S)
651287	Stainless Steel 10 S Economy T-Nut offset	10-32 (10S)
651163	Black Zinc 10 S Economy T-Nut	1/4-20 (10S)
651321	Bright Zinc 10 S Economy T-Nut	1/4-20 (10S)
651322	Bright Zinc 15 S Economy T-Nut	1/4-20 (15S)
651105	Black Zinc 15 S Economy T-Nut offset	1/4-20 (15S)
651294	Stainless Steel 15 S Economy T-Nut	1/4-20 (15S)
651097	Black Zinc 15 S Economy T-Nut offset	5/16-18 (15S)
651316	Bright Zinc 15 S Economy T-Nut offset	5/16-18 (15S)
651288	Stainless Steel 15 S Economy T-Nut offset	5/16-18 (15S)
651386	Bright Zinc 10 S / 25 S Metric Economy T-Nut center	M6x1.0 (10S) (25S)
651366	Bright Zinc 15 S / 40 S Metric Economy T-Nut offset	M6x1.0 (15S) (40S)
651367	Bright Zinc 15 S / 40 S Metric Economy T-Nut offset	M8x1.25 (15S) (40S)
651445	Black Zinc 15 S / 40 S Metric Economy T-Nut	M8x1.25 (15S) (40S)

## DOUBLE ECONOMY T-NUTS



- Economical
- High Strength
- Extrusion end loading only
- 10, 15, 25 & 40 Series sizes
- More convenient and better productivity over single economy T-Nut
- 1", 1.5", 25mm and 40mm centerlines make pre-assembly easy

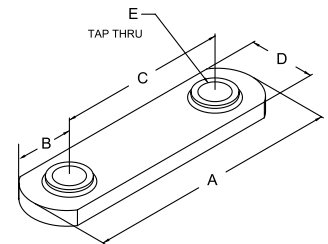

ITEM #	DESCRIPTION	THREAD	A	B	C	D	E
651100	Black Zinc 10 S / 25 S Dbl. Economy T-Nut (10S) (25S)	8-32	1.375	0.187	1	0.443	8-32
651099	Black Zinc 10 S / 25 S Dbl. Economy T-Nut (10S) (25S)	1/4-20	1.875	0.443	1	0.443	1/4-20
651098	Black Zinc 15 S Dbl. Economy T-Nut (15S)	5/16-18	2.81	0.655	1.5	0.625	5/16-18
651331	Bright Zinc 10 S / 25 S Metric Dbl. Economy T-Nut (10S) (25S)	M6x1.0	1.87	0.443	1	0.443	M6x1.0
651406	Bright Zinc 15 S Metric Dbl. Economy T-Nut (15S)	M8x1.25	3	0.75	1.5	0.625	M8x1.25
651461	Black Zinc 40 S Double Economy T-Nut (40S)	M8x1.25	76mm	19mm	40mm	16mm	M8x1.25

## TRIPLE ECONOMY T-NUTS

ITEM #	DESCRIPTION	THREAD	A	B	C	D
651106	Black Zinc 10S Triple Econ. T-Nut (10S)	1/4-20	2.450	0.225	1.000	0.450
651104	Black Zinc 15S Triple Econ. T-Nut (15S)	5/16-18	3.562	0.281	1.500	0.625

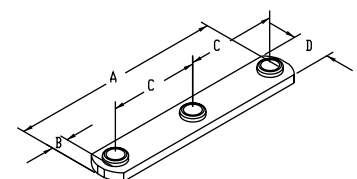

# Fasteners

## STANDARD T-NUTS OFFSET

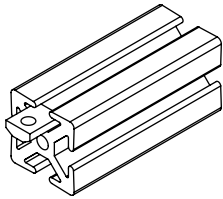

ITEM #	DESCRIPTION	THREAD
651076	Black Zinc 10 S Standard T-Nut	10-32 (10S)
651075	Black Zinc 10 S Standard T-Nut	1/4-20 (10S)
651398	Bright Zinc 10 S / 25 S Standard T-Nut	M5x.8 (10S) (25S)
651400	Bright Zinc 10 S / 25 S Standard T-Nut	M6x1.0 (10S) (25S)
651308	Bright Zinc 15 S Standard T-Nut	5/16-18 (15S)
651393	Bright Zinc 15 S / 40 S Standard T-Nut	M6x1.0 (15S) (40S)
651395	Bright Zinc 15 S / 40 S Standard T-Nut	M8x1.25 (15S) (40S)
651072	Black Zinc 15 S Standard T-Nut	10-32 (15S)
651073	Black Zinc 15 S Standard T-Nut	1/4-20 (15S)
651074	Black Zinc 15 S Standard T-Nut	5/16-18 (15S)
651477	10 S / 25 S Standard T-Nut Profile	36" length (10S) (25S)
651475	15 S / 40 S Standard T-Nut Profile	36" length (15S) (40S)

- 10, 15, 25 and 40 Series sizes
- Extrusion end loading only
- High Strength
- Economical

## DROP IN T-NUTS WITH RUBBER HANDLE

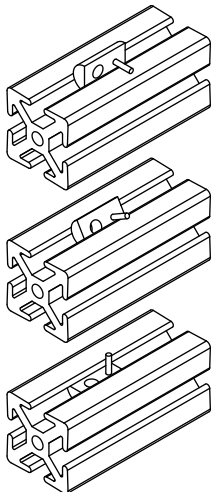
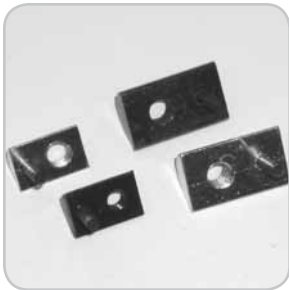

ITEM #	DESCRIPTION	THREAD
651157	Black Zinc 10 S Drop In T-Nut	10-32 (10S)
651325	Bright Zinc 10 S Drop In T-Nut	10-32 (10S)
651435	SS 10 S Drop In T-Nut	1/4-20 (10S)
651326	Bright Zinc 10 S Drop In T-Nut	1/4-20 (10S)
651158	Black Zinc 10 S Drop In T-Nut	1/4-20 (10S)
651402	Bright Zinc 10 S / 25 S Drop In T-Nut	M5x.8 (10S) (25S)
651403	Bright Zinc 10 S / 25 S Drop In T-Nut	M6x1.0 (10S) (25S)
651103	Black Zinc 15 S Drop In T-Nut	10-32 (15S)
651102	Black Zinc 15 S Drop In T-Nut	1/4-20 (15S)
651372	Bright Zinc 15 S / 40 S Drop In T-Nut	M6x1.0 (15S) (40S)
651101	Black Zinc 15 S Drop In T-Nut	5/16-18 (15S)
651318	Bright Zinc 15 S Drop In T-Nut	5/16-18 (15S)
651371	Bright Zinc 15 S / 40 S Drop In T-Nut	M8x1.25 (15S) (40S)
651246	SS 15 S Drop In T-Nut	1/4-20 (15S)

- Tapered bottom allows for easy loading and removal from extrusion slot
- Reduces assembly time
- Easy to add and reposition in T-Slot when ends are closed off
- Rubber nub holds T-Nut in vertical T-Slot
- 10, 15, 25 and 40 Series sizes
- High Strength

## DROP IN T-NUTS WITH SET SCREW



ITEM #	DESCRIPTION	THREAD
651125	Black Zinc 10 S Drop In T-Nut w/ Set Screw	10-32 (10S)
651126	Black Zinc 10 S Drop In T-Nut w/ Set Screw	1/4-20 (10S)
651122	Black Zinc 15 S Drop In T-Nut w/ Set Screw	10-32 (15S)
651123	Black Zinc 15 S Drop In T-Nut w/ Set Screw	1/4-20 (15S)
651247	SS 15 S Drop In T-Nut w/ Set Screw	1/4-20 (15S)
651124	Black Zinc 15 S Drop In T-Nut w/ Set Screw	5/16-18 (15S)
651248	SS 15 S Drop In T-Nut w/ Set Screw	5/16-18 (15S)
651323	Bright Zinc 15 S Drop In T-Nut w/ Set Screw	1/4-20 (15S)
651324	Bright Zinc 15 S Drop In T-Nut w/ Set Screw	5/16-18 (15S)
651421	Bright Zinc 15 S / 40 S Drop In T-Nut w/ Set Screw	M8x1.25 (15S) (40S)
651425	Bright Zinc 15 S / 40 S Drop In T-Nut w/ Set Screw	M6x1.0 (15S) (40S)

- Tapered bottom allows for easy loading and removal from extrusion slot
- Reduces assembly time
- Easy to add and reposition in T-Slot when ends are closed off
- Set screw holds T-Nut in vertical T-Slot
- 10, 15, 25 and 40 Series sizes
- High Strength

## DROP IN T-NUTS WITH BALL BEARING



ITEM #	DESCRIPTION	THREAD
651467	10 S Bright Zinc Drop-in Tnut w/ Ball Bearing	8-32 (10S)
651468	10 S Bright Zinc Drop-in Tnut w/ Ball Bearing	10-32 (10S)
651469 ↺	10 S Bright Zinc Drop-in Tnut w/ Ball Bearing	1/4-20 (10S)
651471	10 S / 25 S Bright Zinc Drop-in Tnut w/ Ball Bearing	M5 x.8 (10S) (25S)
651472	10 S / 25 S Bright Zinc Drop-in Tnut w/ Ball Bearing	M6 x1.0 (10S) (25S)
651642	15 S Bright Zinc Drop-in Tnut w/ Ball Bearing	8-32 (15S)
651643	15 S Bright Zinc Drop-in Tnut w/ Ball Bearing	10-32 (15S)
651644 ↺	15 S Bright Zinc Drop-in Tnut w/ Ball Bearing	1/4-20 (15S)
651645 ↺	15 S Bright Zinc Drop-in Tnut w/ Ball Bearing	5/16-18 (15S)
651646	15 S / 40 S Bright Zinc Drop-in Tnut w/ Ball Bearing	M5 x.8 (15S) (40S)
651647	15 S / 40 S Bright Zinc Drop-in Tnut w/ Ball Bearing	M6 x1.0 (15S) (40S)
651648	15 S / 40 S Bright Zinc Drop-in Tnut w/ Ball Bearing	M8 x1.25 (15S) (40S)

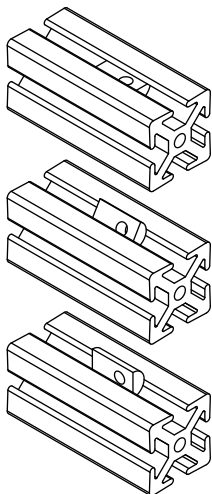

- Tapered bottom allows for easy loading and removal from extrusion slot
- Reduces assembly time
- Easy to add and reposition in T-Slot when ends are closed off
- Ball bearing holds T-Nut in vertical T-Slot
- 10, 15, 25 and 40 Series sizes
- High Strength

# Fasteners

## STEPPED DROP IN T-NUT WITH BALL BEARING



ITEM #	DESCRIPTION	THREAD
664114	15 S Stepped Drop In T-Nut w/ Ball Bearing	1/4-20 (15S)
664115	15 S Stepped Drop In T-Nut w/ Ball Bearing	10-32 (15S)
664116	15 S Stepped Drop In T-Nut w/ Ball Bearing	5/16-18 (15S)
664111	15 S / 40 S Stepped Drop In T-Nut w/ Ball Bearing	M5 (15S) (40S)
664112	15 S / 40 S Stepped Drop In T-Nut w/ Ball Bearing	M6 (15S) (40S)
664113	15 S / 40 S Stepped Drop In T-Nut w/ Ball Bearing	M8 (15S) (40S)

- Zinc plated stainless steel
- Self aligning roll in T-SLOT nut with spring ball

## Z-NUTS (15S) (40S)



ITEM #	DESCRIPTION	THREAD
662002	M5 Z-Nut	M5
662001	M6 Z-Nut	M6

- Design allows for easy loading from extrusion slot
- Fits both 15 S and 40 S slots
- Metric thread size only

## ECONOMY T-SLOT STUDS - Grade 5 (15S)



ITEM #	DESCRIPTION	THREAD
651054	Economy T-SLOT Studs	5/16-18 x 3/4"
651058	Economy T-SLOT Studs	5/16-18 x 1"
651063	Economy T-SLOT Studs	5/16-18 x 1 1/4"
651066	Economy T-SLOT Studs	5/16-18 x 1 1/2"
651107	Economy T-SLOT Studs	5/16-18 x 1 3/4"
651255	S/S Economy T-SLOT Stud	5/16-18 x 3/4"
651261	S/S Economy T-SLOT Stud	5/16-18 x 1"





### ASSEMBLIES

ITEM #	DESCRIPTION
651133	5/16-18 x 3/4" Economy T-SLOT Studs with Washer and Hex Nut

- Extrusion end loading only
- 15 Series sizes

## BUTT FASTENERS

















ITEM #	DESCRIPTION
651153	10 S / 25 S Butt Fastener  
651154	15 S / 40 S Butt Fastener  

- Allows you to butt two extrusions end to end for maximum strength and alignment
- 10, 15, 25 and 40 Series sizes
- » See page 11:08 for machining services.

## ANCHOR FASTENERS









ITEM #	DESCRIPTION
651173	10 S / 25 S Anchor Fastener w/ 10-32 Bolt & Std. T-Nut  
651149	10 S / 25 S Anchor Fastener w/ 10-32 Bolt & Drop In T-Nut  
651500	10 S / 25 S Anchor Fastener w/M6 Bolt & Std. T-Nut  
651174	10 S / 25 S Anchor Fastener - Cam only  
651146	15 S Anchor Fastener w/ 5/16-18 Bolt & Std. T-Nut 
651148	15 S Anchor Fastener w/ 5/16-18 Bolt & Drop In T-Nut 
651281	15 S Anchor Fastener w/ SS 5/16-18 Bolt & Std. T-Nut 
651424	15 S / 40 S Metric Anchor Fastener w/ M8 Bolt & Std. T-Nut  
651147	15 S / 40 S Anchor Fastener - Cam only  

- Strongest of available fasteners
- Creates 90 degree T-Slot connections
- 10, 25 & 40 Series sizes
- All T-Nuts are offset

## DOUBLE ANCHOR FASTENERS



ITEM #	DESCRIPTION
651036	10 S / 25 S 10-32 Short Anchor Assembly  
651038	10 S / 25 S 10-32 Long Anchor Assembly  
651044	15 S 5/16-18 Short Anchor Assembly 
651045	15 S 5/16-18 Long Anchor Assembly 

- Reduces assembly time when mating extrusions have opposing anchor fastener counterbores
- Strongest of available fasteners
- Creates 90 degree T-Slot connections
- 10, 15 and 25 Series Sizes
- » See page 11:08 for machining services.

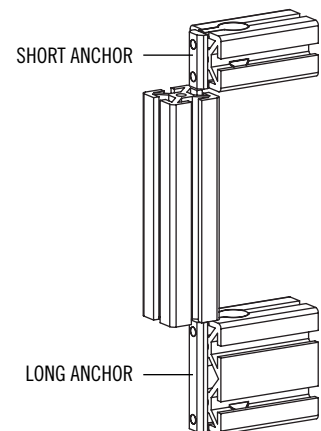

# Fasteners

## END FASTENERS

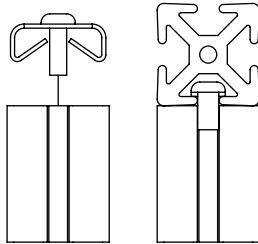

ITEM #	DESCRIPTION	THREAD
651162	Black Zinc 10 S / 25 S End Fastener with Screw	1/4-20 (10S) (25S)
651292	Bright Zinc 10 S / 25 S End Fastener with SS Screw	1/4-20 (10S) (25S)
651422	Bright Zinc 10 S / 25 S End Fastener with Screw	M6x1.0 (10S) (25S)
651291	Bright Zinc 10 S / 25 S End Fastener without Screw	n/a (10S) (25S)
651159	Black Zinc 10 S / 25 S End Fastener without Screw	n/a (10S) (25S)
651161	Black Zinc 15 S / 40 S End Fastener with Screw	5/16-18 (15S) (40S)
651290	Bright Zinc 15 S / 40 S End Fastener with SS Screw	5/16-18 (15S) (40S)
651418	Bright Zinc 15 S / 40 S End Fastener with Screw	M8x1.25 (15S) (40S)
651289	Bright Zinc 15 S / 40 S End Fastener without Screw	n/a (15S) (40S)
651160	Black Zinc 15 S / 40 S End Fastener without Screw	n/a (15S) (40S)

- Provides a hidden fastener when connecting extrusions at 90 degrees
- Mating extrusions glide over end fastener
- Tapping service required in the extrusion base end and access hole in the mating extrusion
- 10, 15, 25 and 40 Series sizes
- Prevents mating extrusion from rotating

## DOUBLE END FASTENERS

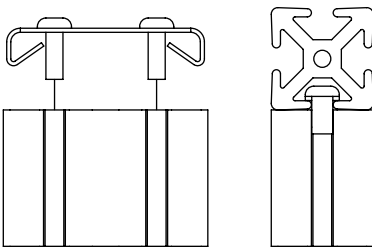





ITEM #	DESCRIPTION	THREAD
651137	Black Zinc 10 S / 25 S Double End Fastener with Screw	1/4-20 (10S) (25S)
651327	Bright Zinc 10 S / 25 S Double End Fastener with SS Screw	1/4-20 (10S) (25S)
651428	Bright Zinc 10 S / 25 S Double End Fastener with Screw	M6x1.0 (10S) (25S)
651329	Bright Zinc 10 S / 25 S Double End Fastener without Screw	n/a (10S) (25S)
651139	Black Zinc 10 S / 25 S Double End Fastener without Screw	n/a (10S) (25S)
651138	Black Zinc 15 S Double End Fastener with Screw	5/16-18 (15S)
651328	Bright Zinc 15 S Double End Fastener with SS Screw	5/16-18 (15S)
651429	Bright Zinc 15 S Double End Fastener with Screw	M8x1.25 (15S)
651330	Bright Zinc 15 S Double End Fastener without Screw	n/a (15S)
651140	Black Zinc 15 S Double End Fastener without Screw	n/a (15S)

- Provides a hidden fastener when connecting extrusions at 90 degrees
- Mating extrusions glide over end fastener
- Tapping service required in the extrusion base end and access hole in the mating extrusion
- 10, 15 and 25 Series sizes
- Prevents mating extrusion from rotating

## CONNECTOR LINK



ITEM #	DESCRIPTION
662005	10 S Connector link - 4" length, 1/4-20 fastener  
662075	15 S Connector link - 6" length, 5/16-18 fastener  

◦ Fastening link to connect similar series profiles together

## MILLING CONNECTOR





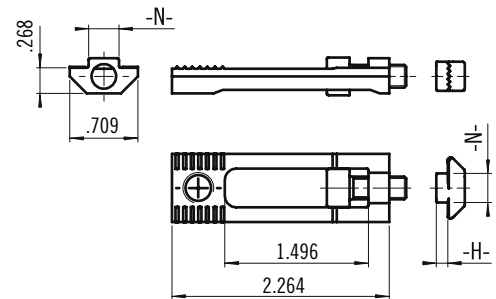

ITEM #	DESCRIPTION
655815	15 S Milling Connector  

◦ For fast connection of two tslot profiles, zinc plated

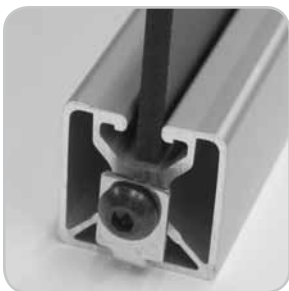

## SINGLE TAB END FASTENER







ITEM #	DESCRIPTION
651495	15 S / 40 S Single Tab End Fastener w/o Screw  
651501	15 S Single Tab End Fastener w/ 5/16-18 BHSCS 
651502	40 S Single Tab End Fastener w/ M8 x 20 mm BHSCS 

- Allows for panels to mate in slots without having to notch panels
- Provides hidden fastener when connecting extrusions at 90°
- Mating extrusions glide over end fastener
- Tapping service required in the extrusion base end and access hole in the mating extrusions
- 15 and 40 Series sizes only

# Fasteners

## PUSH IN FASTENERS



ITEM #	DESCRIPTION
651084	10 S / 25 S Push In Fastener  
651090	15 S / 40 S Push In Fastener  

- Pushes into center holes of 10, 15, 25 and 40 Series extrusions
- Used to fasten End Caps onto extrusions

## BUTTON HEAD SOCKET CAP SCREW & ASSEMBLIES

ITEM #	DESCRIPTION
651020	6-32 x 3/8" BHSCS
651006	8-32 x 1/2" BHSCS
651007	8-32 x 7/8" BHSCS
651008	10-32 x 3/8" BHSCS
651011	10-32 x 1/2" BHSCS
651012	10-32 x 5/8" BHSCS
651015	10-32 x 3/4" BHSCS
651302	S/S 10-32 x 3/8" BHSCS
651304	S/S 10-32 x 1/2" BHSCS
651306	S/S 10-32 x 5/8" BHSCS
651019	1/4-20 x 3/8" BHSCS
651021	1/4-20 x 1/2" BHSCS
651023	1/4-20 x 5/8" BHSCS
651025	1/4-20 x 3/4" BHSCS
651462	1/4-20 x 1" BHSCS
651463	1/4-20 x 1 1/4" BHSCS
651296	S/S 1/4-20 x 3/8" BHSCS
651298	S/S 1/4-20 x 1/2" BHSCS
651284	S/S 1/4-20 x 5/8" BHSCS
651300	S/S 1/4-20 x 3/4" BHSCS

### 10 SERIES / 25 SERIES ASSEMBLIES

ITEM #	DESCRIPTION
651176	1/4-20 x 1/2" BHSCS w/ Washer & Economy T-Nut
651177	1/4-20 x 1/2" BHSCS w/ Washer & Drop In T-Nut
651152	1/4-20 x 5/8" BHSCS w/ Washer
651216	1/4-20 x 3/4" BHSCS w/ Washer & Hex Nut
651171	1/4-20 x 1/2" BHSCS & Economy T-Nut
651172	1/4-20 x 1/2" BHSCS & Drop In T-Nut
651274	S/S 1/4-20 x 5/8" BHSCS w/ Washer & Economy T-Nut
651156	1/4-20 x 3/4" BHSCS w/ Washer & Drop In T-Nut
651490	1/4-20 x 1/2" BHSCS & Double Economy T-Nut
651503	M6 x 12 mm BHSCS & Economy T-Nut
651519	M6 x 12 mm BHSCS & Double Economy T-Nut

ITEM #	DESCRIPTION
651048	5/16-18 x 1/2" BHSCS
651051	5/16-18 x 5/8" BHSCS
651053	5/16-18 x 3/4" BHSCS
651055	5/16-18 x 7/8" BHSCS
651056	5/16-18 x 1" BHSCS
651249	S/S 5/16-18 x 1/2" BHSCS
651251	S/S 5/16-18 x 5/8" BHSCS
651253	S/S 5/16-18 x 3/4" BHSCS
651256	S/S 5/16-18 x 7/8" BHSCS
651259	S/S 5/16-18 x 1" BHSCS
651333	M6 x 12 mm BHSCS
651335	M6 x 16 mm BHSCS
651340	M6 x 20 mm BHSCS
651661	M6 x 20 mm BHSCS Bright Zinc
651341	M6 x 25 mm BHSCS
651343	M8 x 12 mm BHSCS
651345	M8 x 16 mm BHSCS
651347	M8 x 20 mm BHSCS
651351	M8 x 25 mm BHSCS

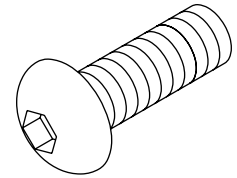

### 15 SERIES / 40 SERIES ASSEMBLIES

ITEM #	DESCRIPTION
651190	5/16-18 x 5/8" BHSCS w/ Washer & Economy T-Nut
651192	5/16-18 x 5/8" BHSCS w/ Washer & Drop In T-Nut
651150	5/16-18 x 5/8" BHSCS & Economy T-Nut
651193	5/16-18 x 3/4" BHSCS w/ Washer & Economy T-Nut
651194	5/16-18 x 3/4" BHSCS w/ Washer & Drop In T-Nut
651195	5/16-18 x 3/4" BHSCS w/ Washer & Hex Nut
651151	5/16-18 x 3/4" BHSCS w/ Washer
651197	5/16-18 x 1" BHSCS w/ Washer & Drop In T-Nut
651265	S/S 5/16-18 x 3/4" BHSCS w/ Washer & Econ T-Nut
651258	S/S 5/16-18 x 5/8" BHSCS w/ Washer & Economy T-Nut
651266	S/S 5/16-18 x 1" BHSCS w/ Washer & Econ T-Nut
651506	M8 x 16 mm BHSCS & Economy T-Nut
651507	M8 x 16 mm BHSCS & Standard T-Nut
651521	M8 x 16 mm BHSCS & Double Economy T-Nut

» See page 01:02 for torque specifications.

# Fasteners

## SOCKET HEAD CAP SCREWS & ASSEMBLIES

ITEM #	DESCRIPTION	ITEM #	DESCRIPTION
658588	8-32 x 3/4" SHCS	651262	S/S 5/16-18 x 1 1/4" SHCS
658589	8-32 x 1" SHCS	651049	5/16-18 x 1/2" SHCS
651009	10-32 x 3/8" SHCS	651050	5/16-18 x 5/8" SHCS
651010	10-32 x 1/2" SHCS	651052	5/16-18 x 3/4" SHCS
651013	10-32 x 5/8" SHCS	651057	5/16-18 x 7/8" SHCS
651293	S/S 10-32 x 3/4" SHCS	651059	5/16-18 x 1" SHCS
651301	S/S 10-32 x 3/8" SHCS	651060	5/16-18 x 1 1/4" SHCS
651303	S/S 10-32 x 1/2" SHCS	651064	5/16-18 1 1/2" SHCS
651305	S/S 10-32 x 5/8" SHCS	651650	5/16-18 x 1 3/4" SHCS
651017	10-32 x 3/4" SHCS	651651	5/16-18 x 2" SHCS
651018	1/4-20 x 3/8" SHCS	651652	5/16-18 x 2 1/4" SHCS
651022	1/4-20 x 1/2" SHCS	651653	5/16-18 x 2 1/2" SHCS
651024	1/4-20 x 5/8" SHCS	651654	5/16-18 x 3" SHCS
651027	1/4-20 x 3/4" SHCS	651488	5/16-18 x 3 1/2" SHCS
651028	1/4-20 x 7/8" SHCS	651061	3/8-16 x 1" SHCS
651029	1/4-20 x 1" SHCS	651062	3/8-16 x 3/4" SHCS
651030	1/4-20 x 1 1/4" SHCS	699933	M5 x 16 mm SHCS
651031	1/4-20 x 1 1/2" SHCS	651332	M6 x 12 mm SHCS
651489	1/4-20 x 2 1/2" SHCS	651546	M6 x 14 mm SHCS
651295	S/S 1/4-20 x 3/8" SHCS	651334	M6 x 16 mm SHCS
651297	S/S 1/4-20 x 1/2" SHCS	651337	M6 x 20 mm SHCS
651299	S/S 1/4-20 x 3/4" SHCS	651338	M6 x 25 mm SHCS
651286	S/S 1/4-20 x 1" SHCS	658592	M6 x 35 mm SHCS
651250	S/S 5/16-18 x 1/2" SHCS	651342	M8 x 12 mm SHCS
651252	S/S 5/16-18 x 5/8" SHCS	651344	M8 x 16 mm SHCS
651254	S/S 5/16-18 x 3/4" SHCS	651346	M8 x 20 mm SHCS
651257	S/S 5/16-18 x 7/8" SHCS	651350	M8 x 25 mm SHCS
651260	S/S 5/16-18 x 1" SHCS	651354	M8 x 30 mm SHCS

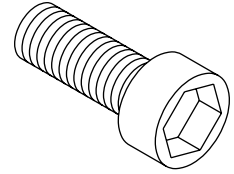

### 10 SERIES / 25 SERIES ASSEMBLIES

ITEM #	DESCRIPTION
651235	1/4-20 x 1/2" SHCS & Drop In T-Nut
651234	1/4-20 x 1/2" SHCS & Economy T-Nut
651235	1/4-20 x 1/2" SHCS & Drop In T-Nut
651236	1/4-20 x 5/8" SHCS & Economy T-Nut
651117	1/4-20 x 3/4" SHCS & Economy T-Nut
651175	1/4-20 x 3/4" SHCS & Drop In T-Nut
651118	1/4-20 x 7/8" SHCS & Economy T-Nut
651119	1/4-20 x 1" SHCS & Econ T-Nut
651120	1/4-20 x 1 1/4" SHCS & Econ T-Nut
651121	1/4-20 x 1-1/2" SHCS & Econ T-Nut

### 15 SERIES / 40 SERIES ASSEMBLIES

ITEM #	DESCRIPTION
651199	5/16-18 x 1/2" SHCS & Economy T-Nut
651201	5/16-18 x 5/8" SHCS & Economy T-Nut
651202	5/16-18 x 3/4" SHCS & Economy T-Nut
651205	5/16-18 x 7/8" SHCS & Economy T-Nut
651207	5/16-18 x 7/8" SHCS & Drop In T-Nut
651209	5/16-18 x 5/8" SHCS w/ Washer & Economy T-Nut
651213	5/16-18 x 3/4" SHCS w/ Washer & Economy T-Nut
651215	5/16-18 x 3/4" SHCS w/ Washer & Drop In T-Nut
651198	5/16-18 x 7/8" SHCS w/ Washer & Hex Nut
651217	5/16-18 x 1" SHCS w/ Washer & Economy T-Nut
651267	S/S 5/16-18 x 1/2" SHCS & Economy T-Nut
651268	S/S 5/16-18 x 5/8" SHCS & Economy T-Nut
651482	5/16-18 x 1 1/4" SHCS & Economy T-Nut
651487	5/16-18 x 1 1/2" SHCS & Economy T-Nut
651485	5/16-18 x 3" SHCS & Economy T-Nut
651512	M8 x 16 mm SHCS & Economy T-Nut

» See page 01:02 for torque specifications.

## FLANGED BUTTON HEAD SOCKET CAP SCREWS & ASSEMBLIES

ITEM #	DESCRIPTION
651169	1/4-20 x 3/8" Flanged BHSCS
651136	1/4-20 x 1/2" Flanged BHSCS
651026	1/4-20 x 3/4" Flanged BHSCS
651134	5/16-18 x 11/16" Flanged BHSCS
651135	5/16-18 x 1/2" Flanged BHSCS
651634	5/16-18 x 11/16" Flanged BHSCS w/Loctite

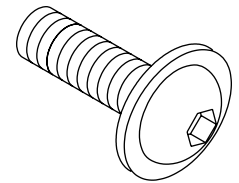

### 10 SERIES ASSEMBLIES

ITEM #	DESCRIPTION
651002	1/4-20 x 3/8" FBHSCS w/ Washer & Hex Nut
651166	1/4-20 x 3/8" FBHSCS & Economy T-Nut
651130	1/4-20 x 1/2" FBHSCS & Economy T-Nut
651224	1/4-20 x 1/2" FBHSCS & Drop In T-Nut
651164	1/4-20 x 3/4" FBHSCS & Economy T-Nut
651228	1/4-20 x 3/4" FBHSCS & Drop In T-Nut
651142	1/4- 20 x 1/2" FBHSCS & Double Economy T-Nut
651144	1/4-20 x 1/2" FBHSCS & Triple Economy T-Nut

### 15 SERIES ASSEMBLIES

ITEM #	DESCRIPTION
651127	5/16-18 x 1/2" FBHSCS & Drop In T-Nut
651128	5/16-18 x 1/2" FBHSCS & Economy T-Nut
651129	5/16-18 x 11/16" FBHSCS & Economy T-Nut
651132	5/16-18 x 5/8" FBHSCS & Drop In T-Nut
651210	5/16-18 x 5/8" FBHSCS w/ Washer & Hex Nut
651141	5/16-18 x 11/16" FBHSCS & Double Econ. T-Nut
651143	5/16-18 x 11/16" FBHSCS & Triple Economy T-Nut

## FLATHEAD SOCKET CAP SCREW & ASSEMBLIES

ITEM #	DESCRIPTION
651188	6-32 x 3/8" FHSCS - Black Zinc
651005	10-32 x 1/2" FHSCS
651179	10-32 x 1/2" FHSCS - Black Zinc
651178	1/4-20 x 1/2" FHSCS - Black Zinc
651180	1/4-20 x 5/8" FHSCS - Black Zinc
651181	5/16-18 x 5/8" FHSCS - Black Zinc
651182	5/16-18 x 3/4" FHSCS - Black Zinc
651187	3/8-16 x 3/4" FHSCS - Black Zinc
651515	M6 x 12 mm FHSCS
651516	M6 x 16 mm FHSCS
651549	M6 X 20 mm FHSCS
651517	M8 x 16 mm FHSCS
651518	M8 x 20 mm FHSCS

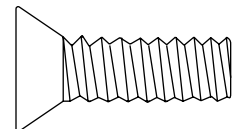

### ASSEMBLIES

ITEM #	DESCRIPTION
651185	1/4-20 x 1/2" FHSCS & Economy T-Nut - 10 S
651183	5/16-18 x 5/8" FHSCS & Economy T-Nut
651545	1/4-20 x 5/8" FHSCS & Economy T-nut - 15 S

# Fasteners

---

## LOWHEAD SOCKET CAP SCREW

---

ITEM #	DESCRIPTION
651474	1/4-20 x 3/8" LHSCS
651003	1/4-20 x 1" LHSCS
699955	5/16-18 x 5/8" LHSCS
651004	5/16-18 x 1 1/4" LHSCS

» See page 01:02 for torque specifications.

## WASHERS AND HEX NUTS

---

### WASHERS

ITEM #	DESCRIPTION
651016	10-32 Flat Washer
651080	1/4" Flat Washer
651081	5/16" Flat Washer
651082	3/8" Flat Washer
651083	1/2" Flat Washer

### HEX NUTS

ITEM #	DESCRIPTION
651014	10-32 Hex Nut
651077	1/4-20 Hex Nut
651078	5/16-18 Hex Nut
651079	3/8-16 Hex Nut
651310	5/16-18 Bright Zinc Hex Nut

